

Varenummer: 3901250050700
 Beskrivelse: Snekkegear med fri indgangsaksel
 VF 250P-50-HS

Mål

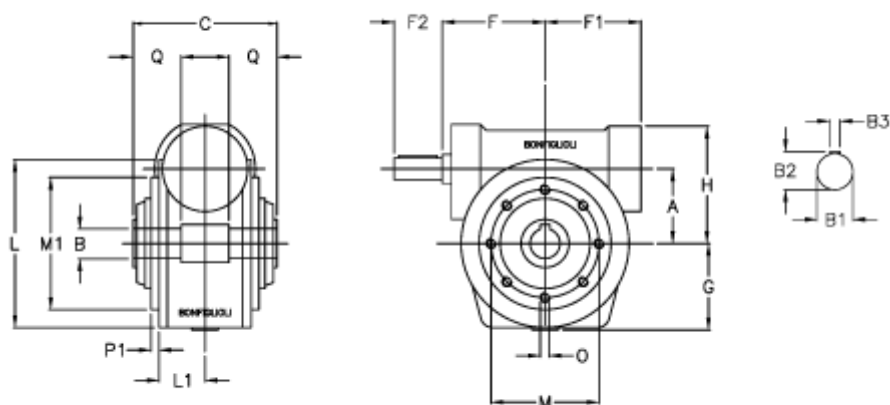

a	= 250.0	F1	= 318	O	= M16x40
B	= 110	F2	= 110	P1	= 5.0
B1	= 55	g	= 265	Q	= 85.0
B2	= 59.0	H	= 370		
B3	= 16	L	= 450.0		
Betegnelse	= VF 250P-xx-HS	L1	= 310.0		
C	= 320	m	= 400		
F	= 276.0	M1	= 350		